

Integrated Wellbore Integrity Analysis Program for CO₂ Storage Applications

DE-FE0026585

J.R. Sminchak and Mark Moody
Battelle, Columbus, Ohio, USA

BATTELLE

U.S. Department of Energy
National Energy Technology Laboratory
Mastering the Subsurface Through Technology Innovation, Partnerships and Collaboration:
Carbon Storage and Oil and Natural Gas Technologies Review Meeting
August 1-3, 2017

Presentation Outline

- 1) Technical Status
 - 2) Accomplishments to Date
 - 3) Lessons Learned
 - 4) Synergy Opportunities
 - 5) Project Summary
- Appendix Material



1966 Gordon Sand Well

Acknowledgements

- The project was funded by the U.S. DOE / National Energy Technology Laboratory under their program on technologies to ensure permanent geologic carbon storage (Contract DE-FE0026585).
Project Manager – William O’Dowd, NETL.
- Project team includes Battelle (Lead), Core Energy, West Virginia Geologic and Economic Survey (WVGES), Petroleum Technology Resource Center (PTRC) for SCP testing and well construction analysis Williston Basin.



U.S. DEPARTMENT OF
ENERGY



CORE ENERGY, LLC

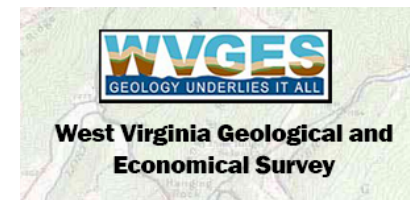

Technical Status- Objectives

- Geologic CO₂ storage may affect legacy oil and gas wells.
- For example, there are more than 1 million oil & gas wells in Midwest U.S. since ~1859.
- What is the condition of these wells?
- How would exposure to CO₂ in the deep subsurface affect these wells?
- What can we learn from testing and monitoring these wells?
- Are CO₂ wells in any better/worse condition than typical oil and gas wells?

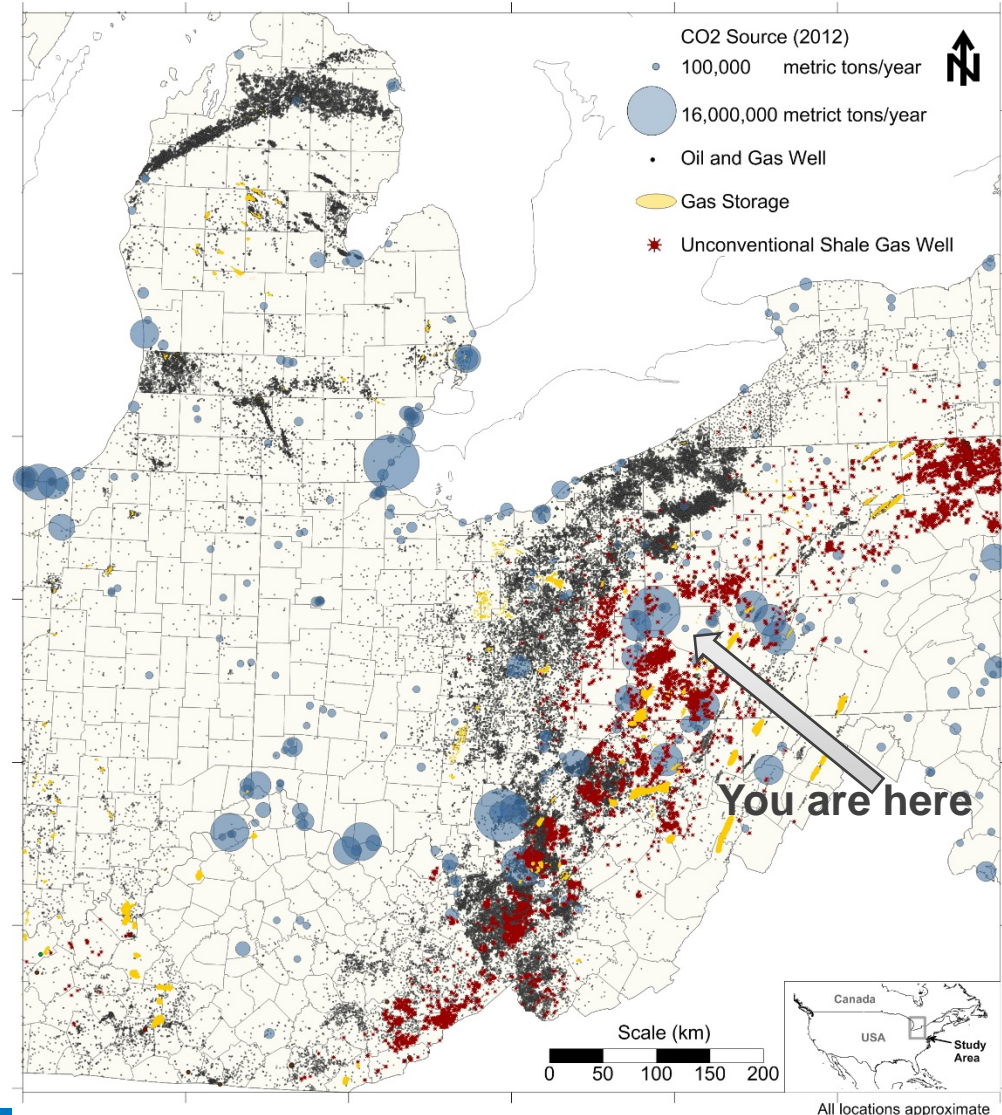

Technical Status- Objectives

- **Objective:** develop & validate a program for identifying and characterizing wellbore integrity in legacy oil and gas wells for CO₂ storage applications based on analytics of well records validated with sustained casing pressure testing.
 1. Determine the nature of well defects, location within the borehole, and severity of the well defects via SCP tests on CO₂ wells.
 2. Integrate results with analysis of wells exposed to CO₂ at study areas in Michigan Basin, Appalachian Basin, & Williston Basin.
- Project results will provide predictive methods to survey, identify, characterize, and manage wellbore integrity for CO₂ storage applications.

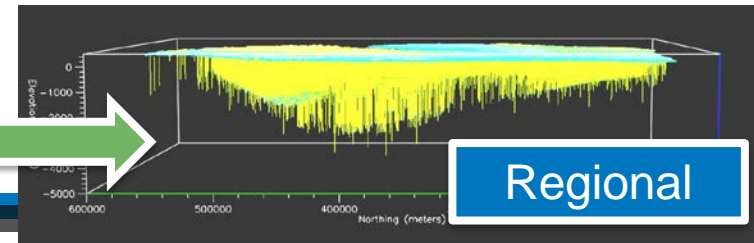

Technical Status- Objectives

- 3 year project from October 2015-September 2018 divided into 6 main technical tasks.
- Project team includes Battelle (Lead), Core Energy, PTRC (well testing in Williston Basin), and the West Virginia Geologic and Economic Survey (WVGES).

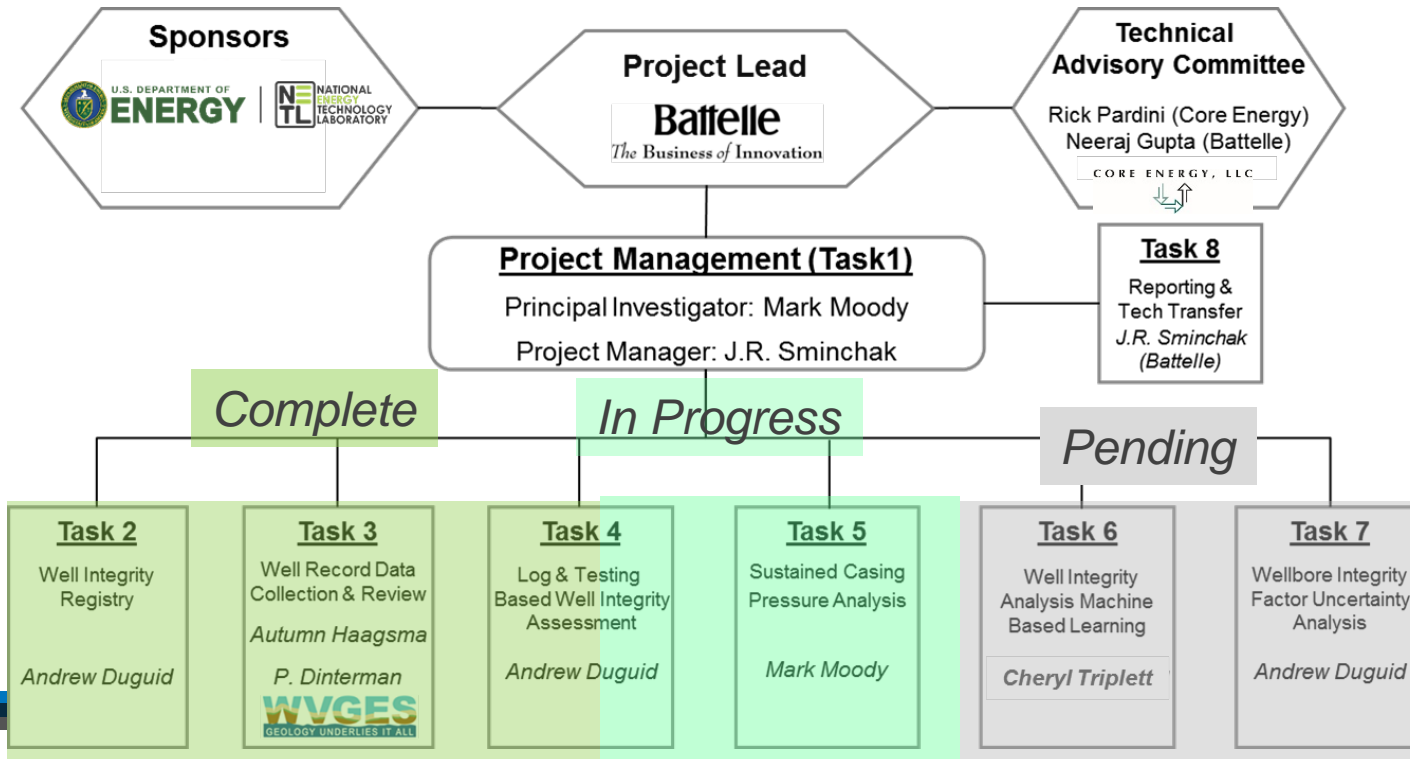

Technical Status- Objectives

- Test selected CO₂ wells at 2-3 sites for sustained casing pressure response.
- Analyze casing pressure buildup to estimate the nature, depth, and severity of well defects. This testing provides direct measurement combined well defects.
- Compare test results to well records with statistical based machine learning to define well construction factors that may be most relevant to CO₂ storage applications.
- Analyze this information to better understand the risks that legacy boreholes may pose for CO₂ storage in the region.

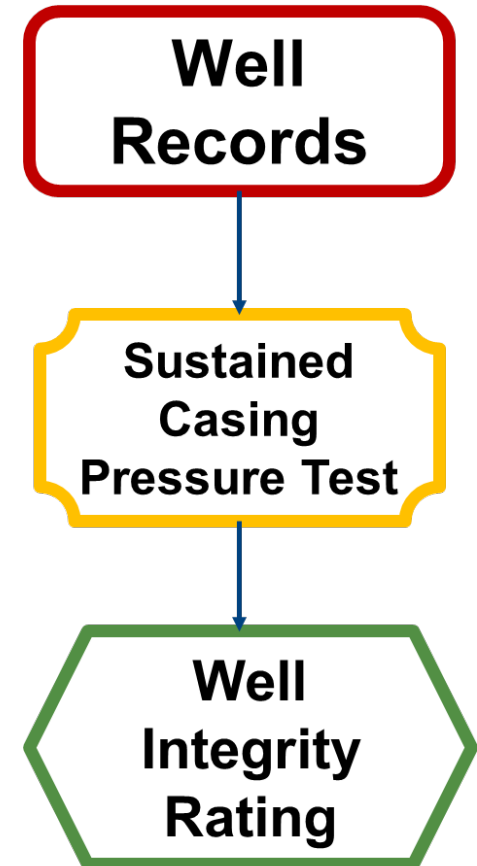

Technical Status

- Well registry developed to identify wellbore integrity issues, and where and how they occur in the subsurface
- Five subtasks defined:

Well Construction

- Methods
- Materials

Well Casing

- Corrosion/wear
- Leaks

Well Cement

- Contamination
- Defects

Geologic Processes

- Geomechanical
- Geochemical

CO2 Environments

- Influence of CO2 of cement, casing, etc.

- Information was used to characterize the three study areas

| Well Component | Integrity Issue | Description | Causes | When | Leakage Pathway |
|------------------------------------|---------------------------|--|---|--|--|
| Casing | Thermo-mechanical cycling | Contraction and expansion of well casing | Differences between properties of materials | Construction, operation, workover, abandonment | Debonding along cement interface (microannulus) |
| | Wear | Wear to the casing | Casing interactions with wellbore and tools | After drilling, during workovers | Burst, collapse, holes in casing |
| | Corrosion | Corrosion of casing | Contact with corrosive fluids saturated with CO ₂ | Construction, operation, workover, abandonment | Holes in casing, cracking |
| Cement | Degradation | Dissolution or alteration of cement | Contact with corrosive fluids saturated with CO ₂ | Construction, operation, workover, abandonment | Pores in cement or along degraded cement at interfaces |
| | Microannulus and cracking | A small gap between casing and cement and cracks in the cement | Casing and cement debond, or bond was never established or was broken | Construction, operation, workover, abandonment | Along casing-cement interface |
| | Mud contamination | Poor mud removal before cementing | Poor cement job design, poor hole cleanout | During construction | Along interfaces or through bulk cement |
| | Eccentering | Casing is not centered in the borehole | Poor centralization | During construction | Along casing, cement, or mud interfaces |
| | Mud channels | Cement slurry fingers through the mud in the annulus | Poor cement job design | During construction | Along mud channel interface or through flowing mud |
| Borehole wall (Geologic Processes) | Fluid invasion | Invasion of fluids into cement | Poor cement slurry design and loss of hydrostatic pressure | During construction | Poor zonal isolation |
| | Formation lithology | Borehole breakout and drilling induced fractures | Induced stress greater than maximum of the formation stress | During drilling | Poor cement bond to borehole wall |
| | Geomechanical stresses | Changes in stress field | Pressure gradient changes and creep | Construction, operation, workover, abandonment | Cement and casing damage or failure |

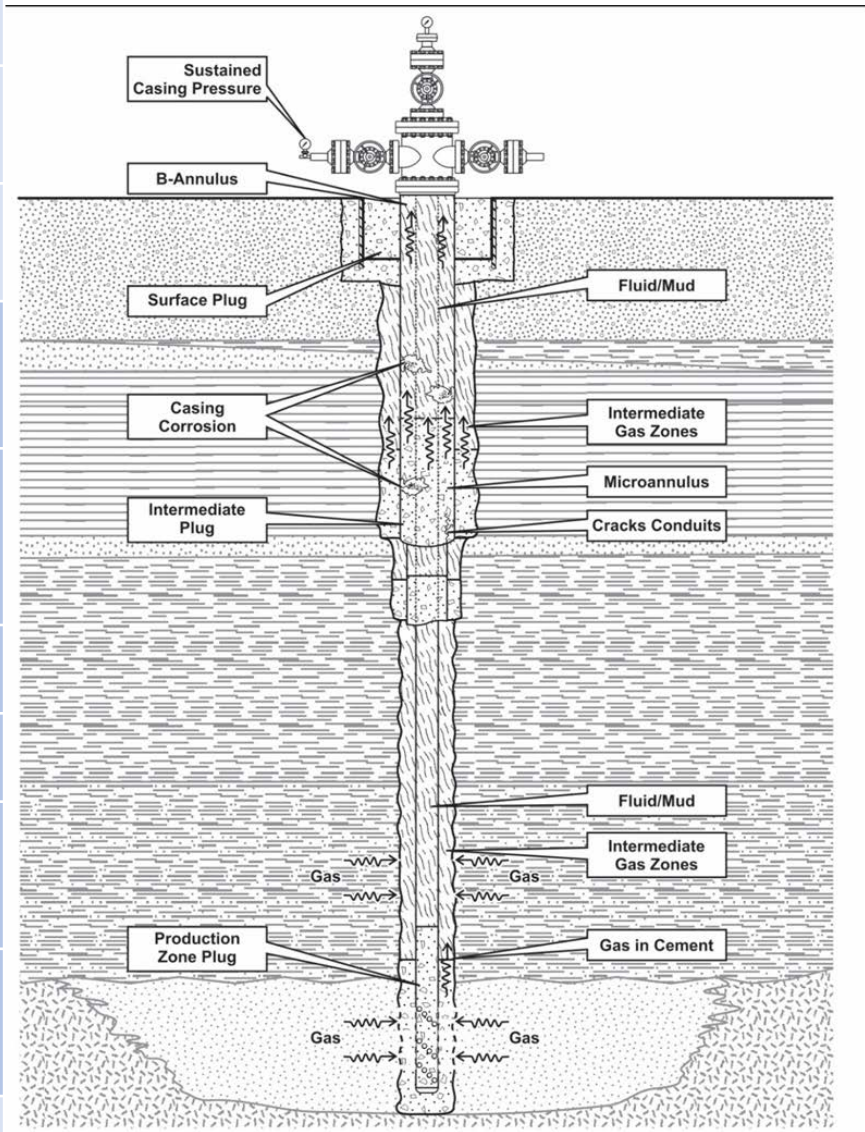

Not to Scale

WELL_SCENARIOS.COR

Technical Status

- 3 study areas were examined, because they had existing oil and gas wells exposed to CO₂.
- Study areas were characterized in terms of geology, well construction, field production, & CO₂ exposure.

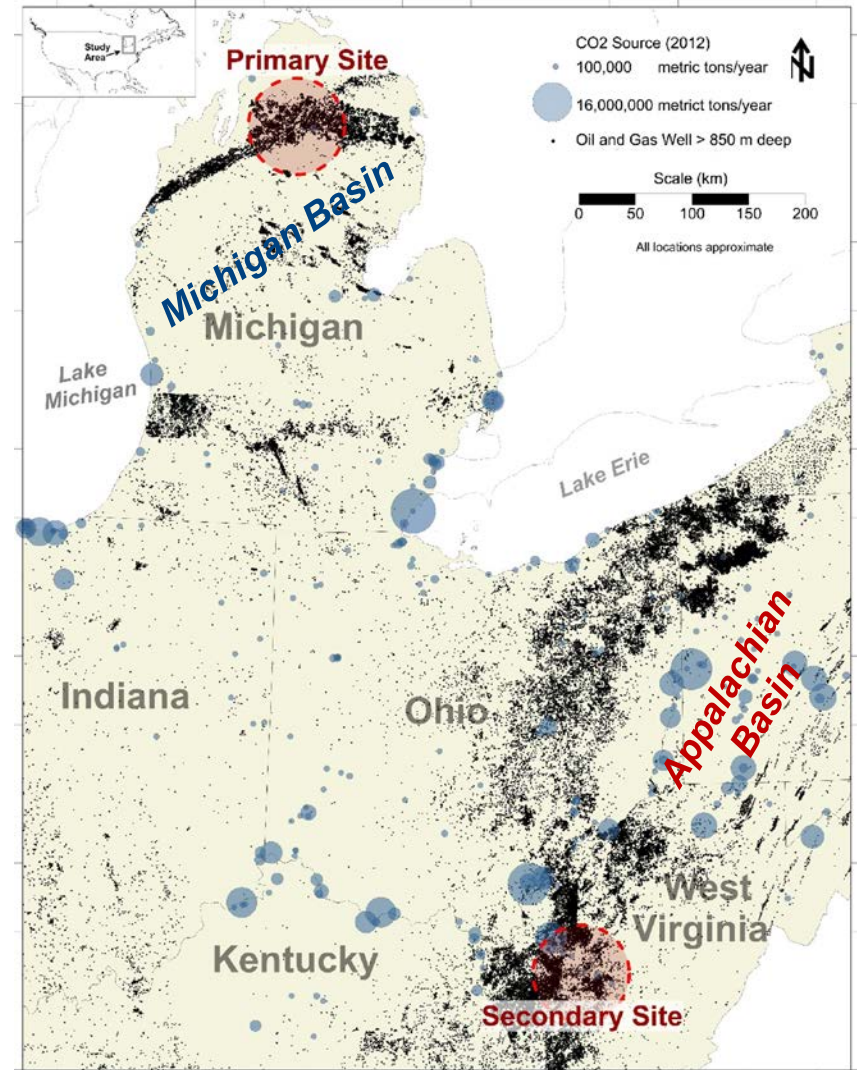
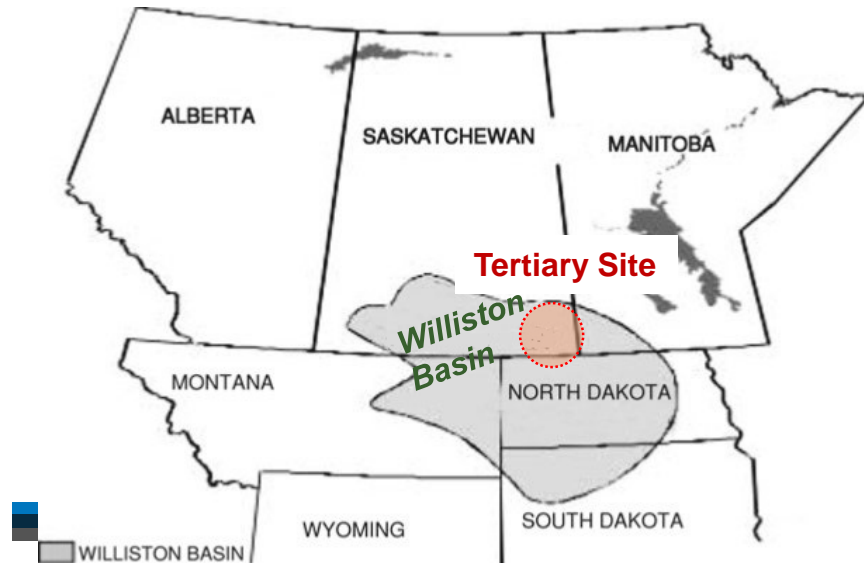

Technical Status

- **Appalachian Basin site:** high natural CO₂ levels in a sandstone reservoir at ~1,900 m depth.
- 20-83% natural CO₂ in areas of the field.
- 58 wells circa 1960-2003.

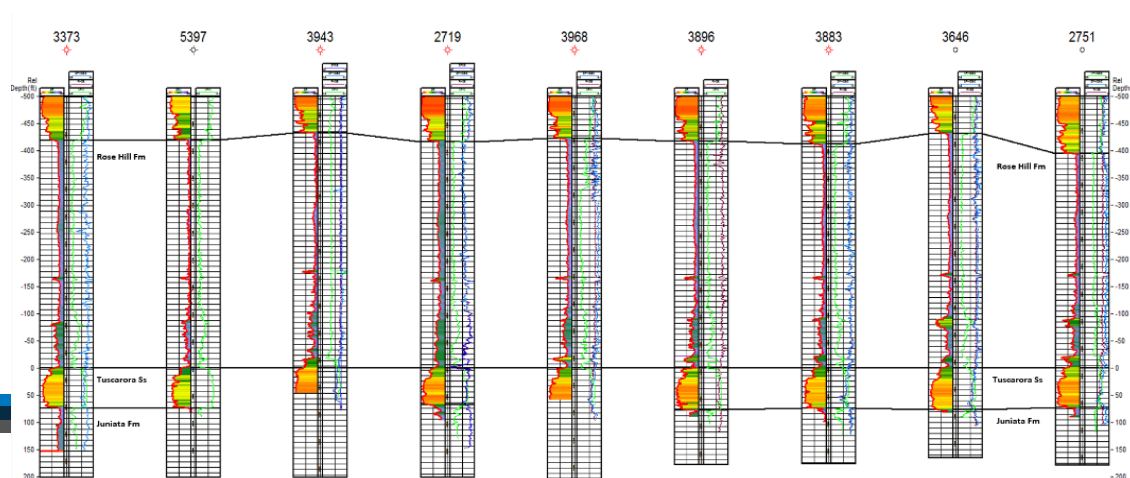
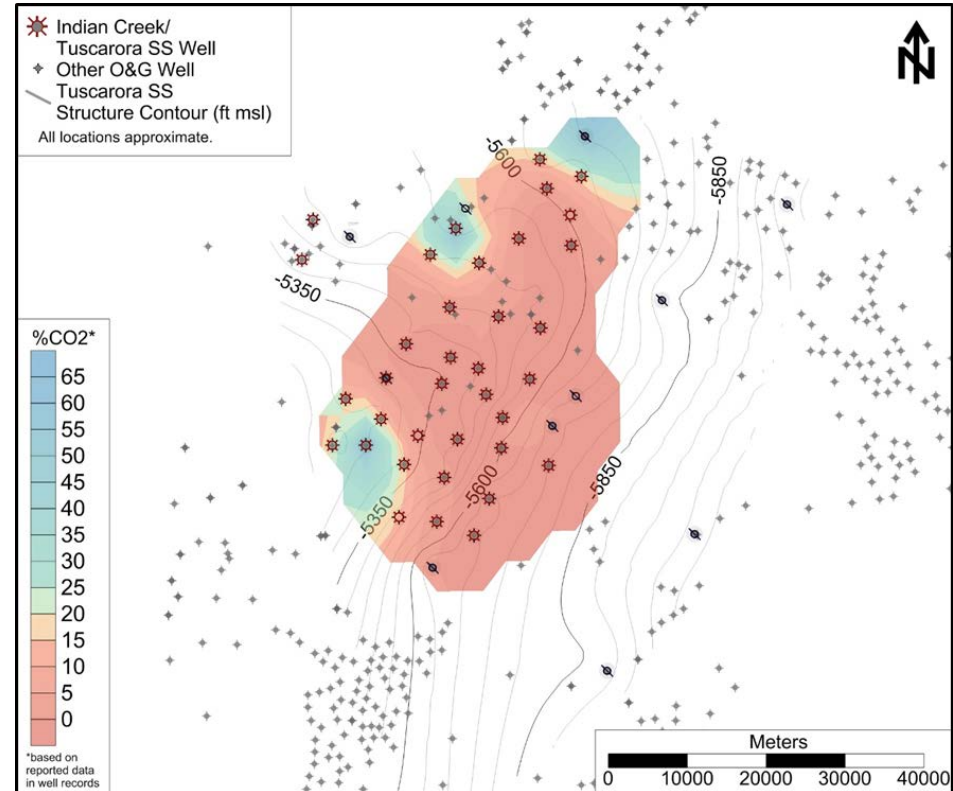

Technical Status

- Appalachian Basin site
- Wells exposed to natural CO₂ accumulation at depth of 6200 ft (1900 m) in the Tuscarora sandstone.

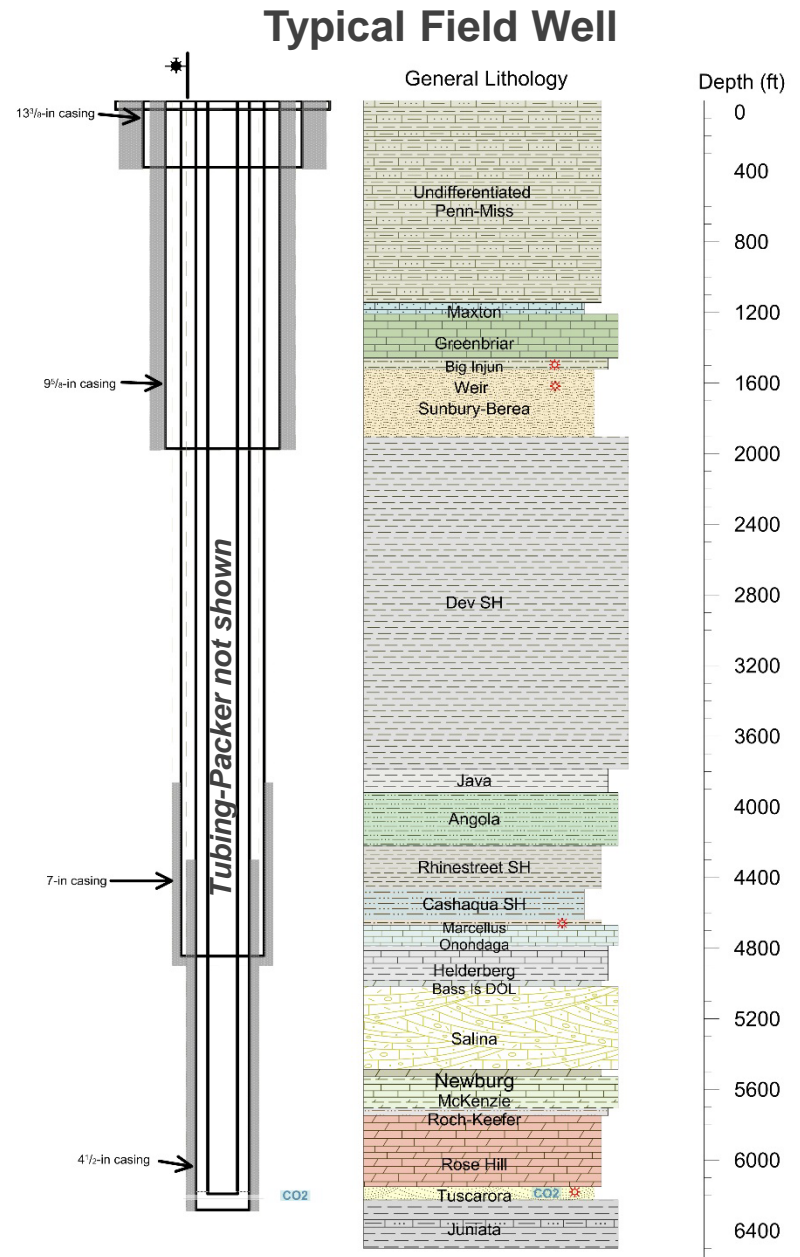

Technical Status

- Michigan Basin site
- 100's existing wells circa 1960-2016.
- 20-30 wells in CO₂ EOR fields.
- 5-30% CO₂ in Antrim Shale, 300-500 m.
- 95-99% CO₂ in EOR zone at 1,500-2000 m.

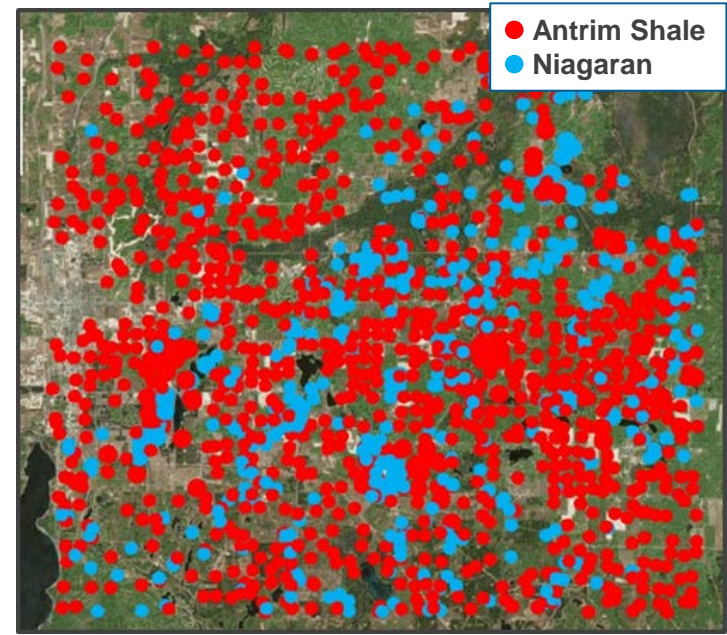

Antrim Shale CO₂ % in Produced Gas Volume

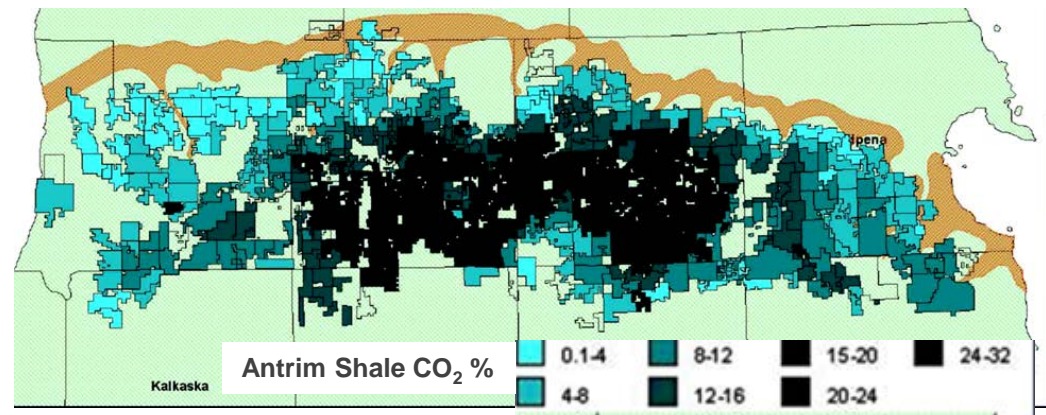

(Source: Goodman et al, 2014)

Technical Status

- Michigan Basin site has wells with high natural CO₂ levels in a relatively shallow (350 m) shale gas play, and a deeper (1850 m) carbonate reef CO₂ enhanced oil recovery field.

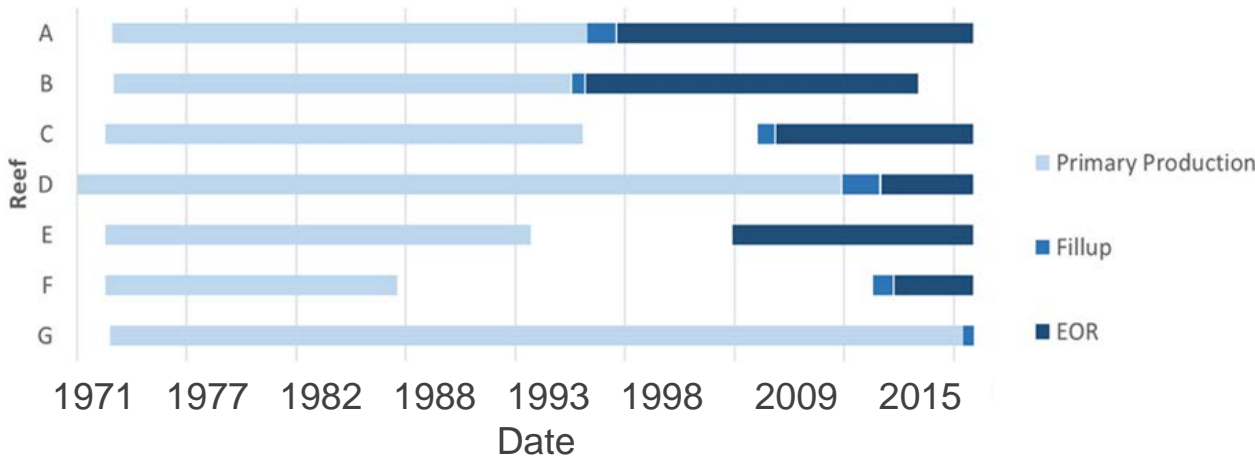
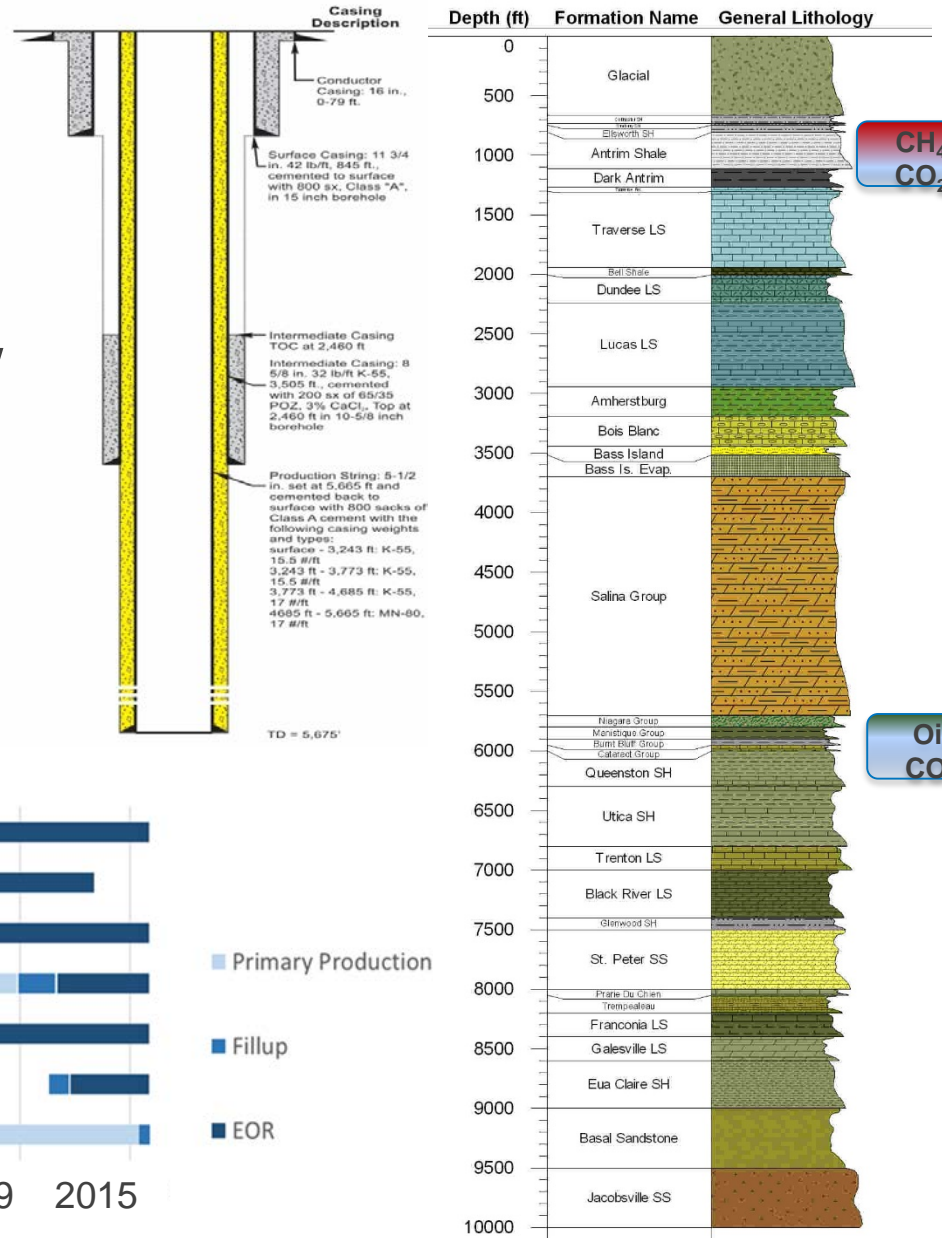

Technical Status

- **Williston Basin site** has ~3000 wells, and 1425 were examined in this study.
- The wells were primarily oil producers with select wells used for H₂O or CO₂ injection.
- Wells used for CO₂ & H₂O injection. Some H₂S gas present.
- Well age ranges from 1950s to 2000s.
- EOR zone at 1500 m.

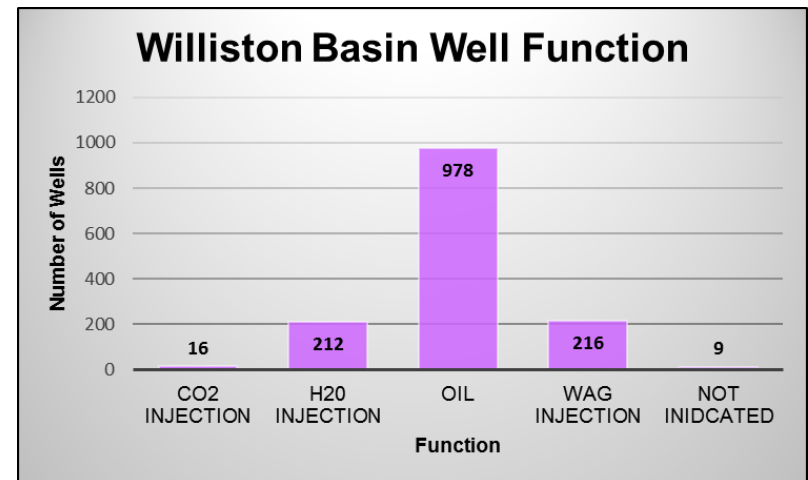
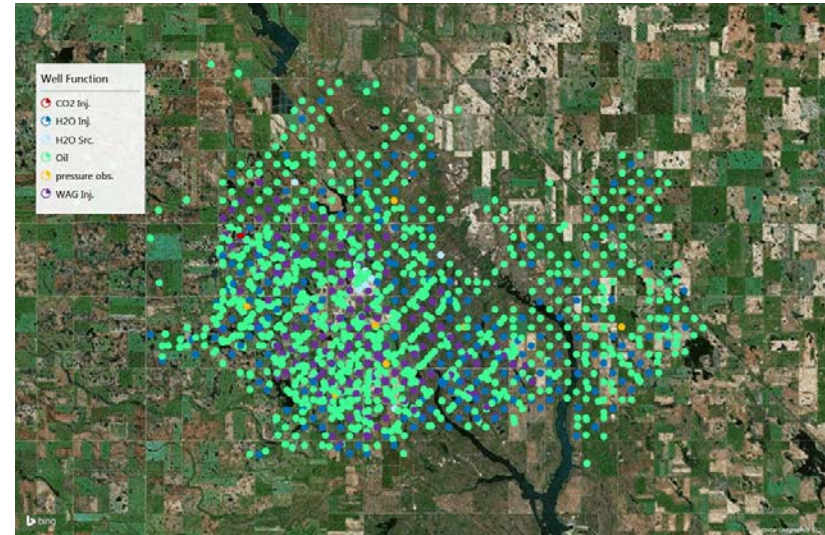

Technical Status- SCP testing

- Well defects may result in “sustained casing pressure” or vent flow gas.
- Gas migrates through casing/cement into ‘B’ annulus.
- Pressure vs time and rate vs time can be analyzed for information on nature of defect, severity, and location.

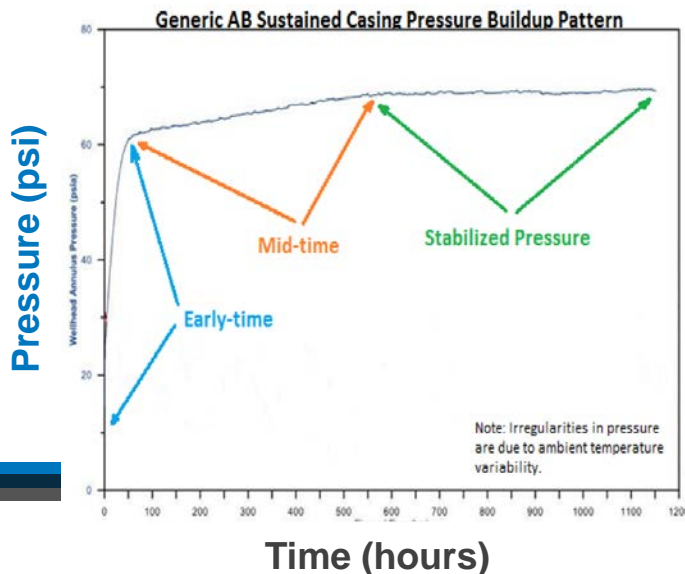
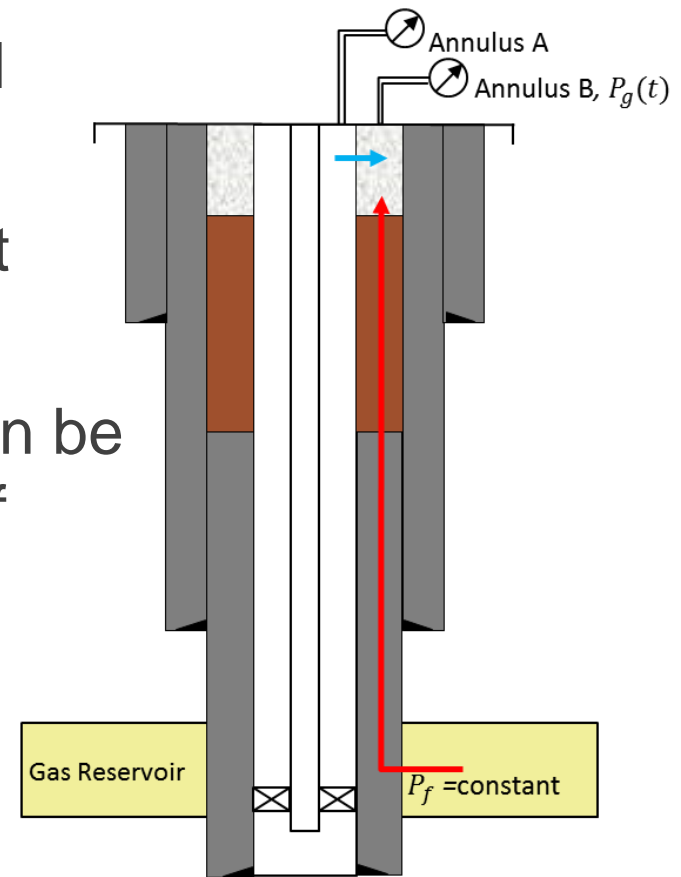

Technical Status- SCP testing

- SCP testing procedure:
 - Confirm wellhead configuration!
 - Measure initial pressure on b-annulus
 - Vent gas and measure gas volume
 - Collect gas sample for analysis
 - Install pressure/temp logger
 - Log pressure build-up (1-8 weeks)
 - Remove logger
 - Analyze results
- No interruption in well operations!

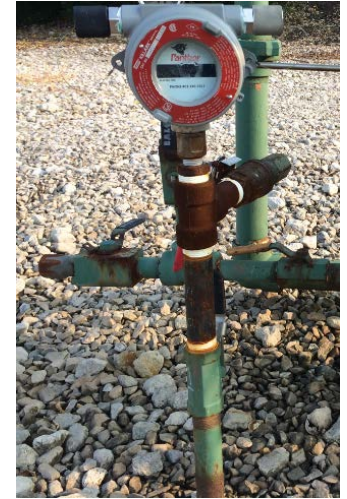

Pressure Build-Up Monitoring

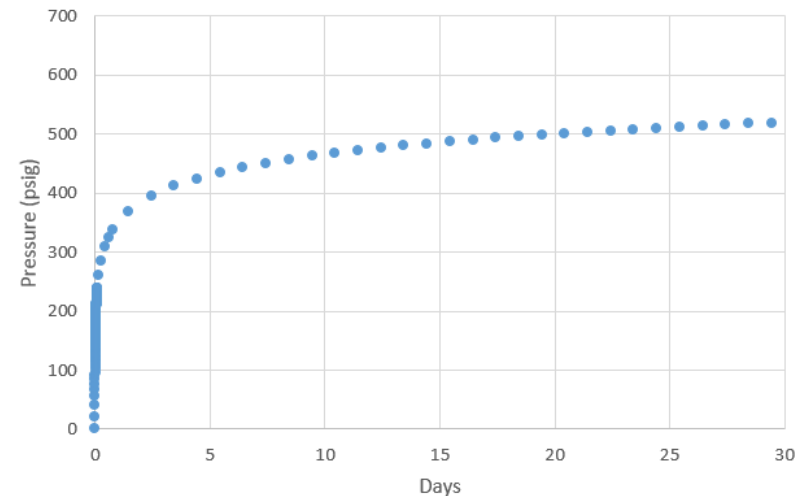

Technical Status- SCP testing

- SCP testing equipment and methods are fairly routine for gas storage field operators.

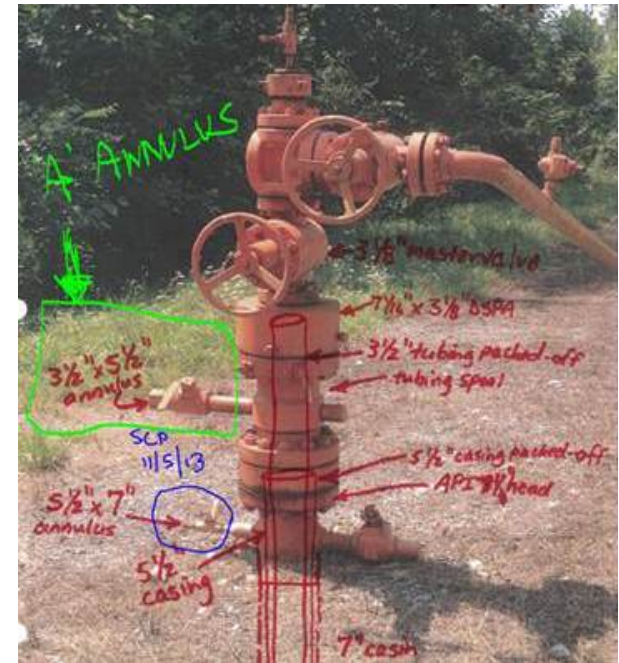

Technical Status

- SCP testing analysis method developed to analyze legacy well because they often have various well defects (Dotson et al., 2015).

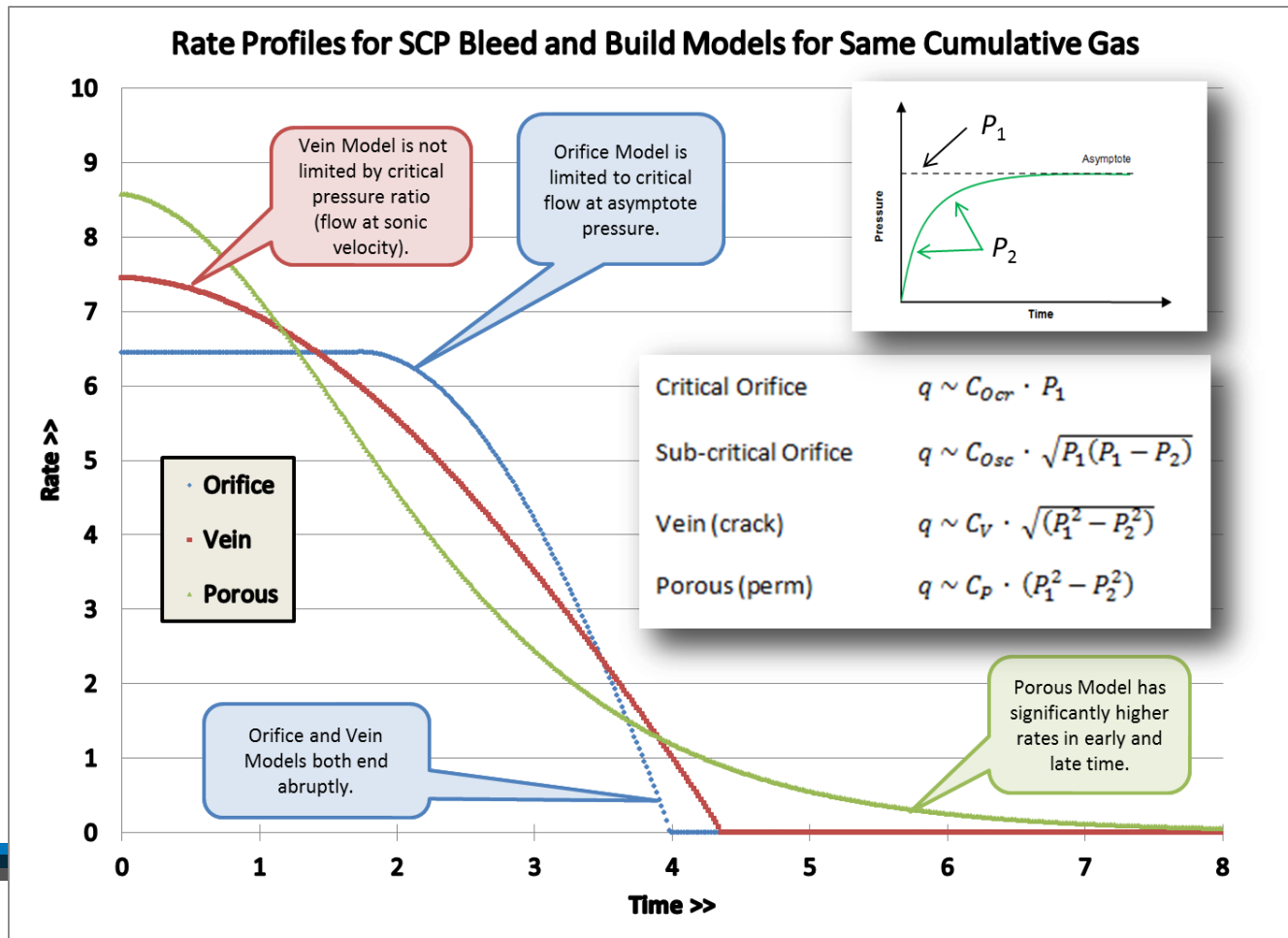

Technical Status

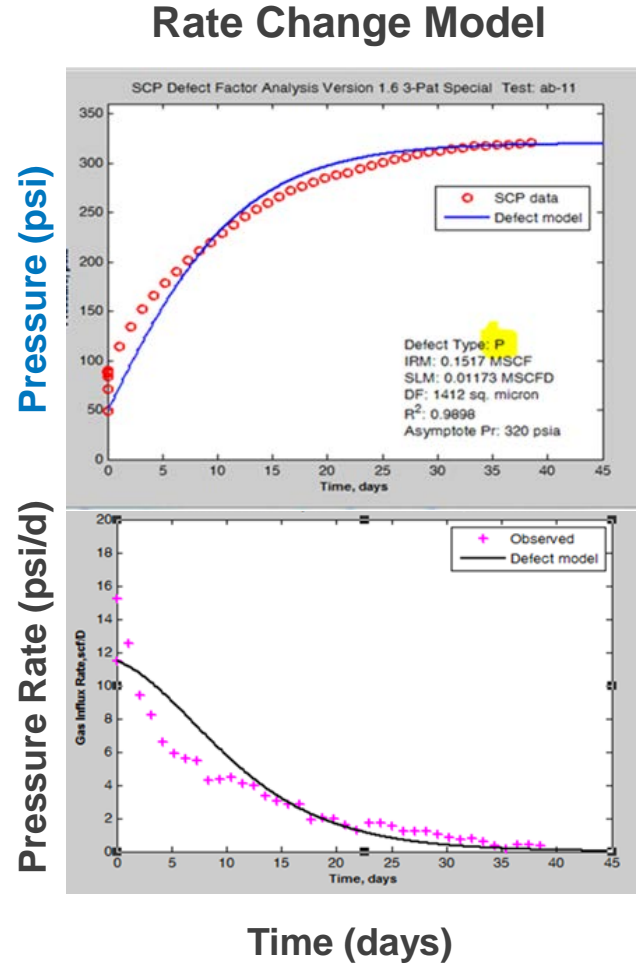
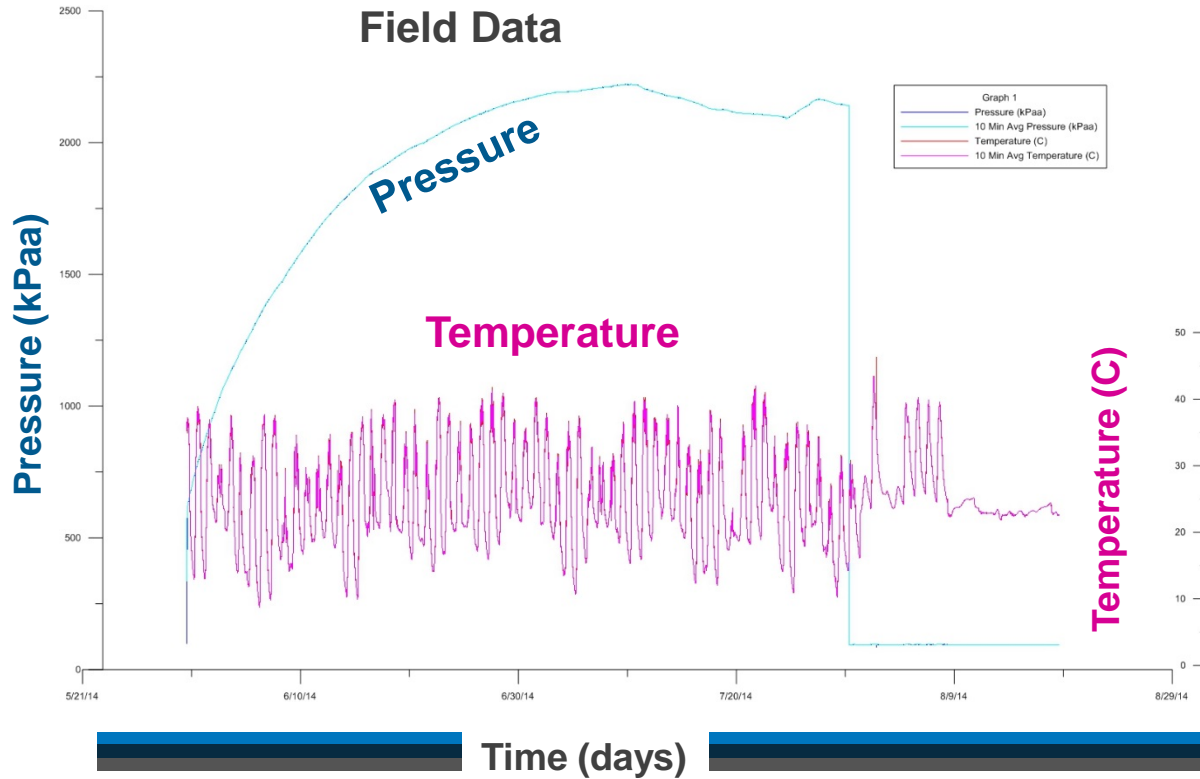
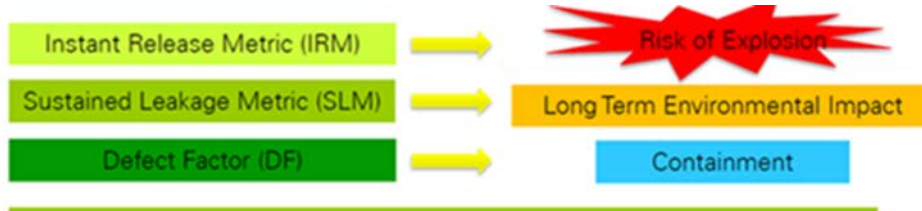

Technical Status

- Sustained casing pressure testing kits were constructed to test wells using methodology by Dotson et al., 2015.
- Allows operators to test many wells exposed to CO₂.

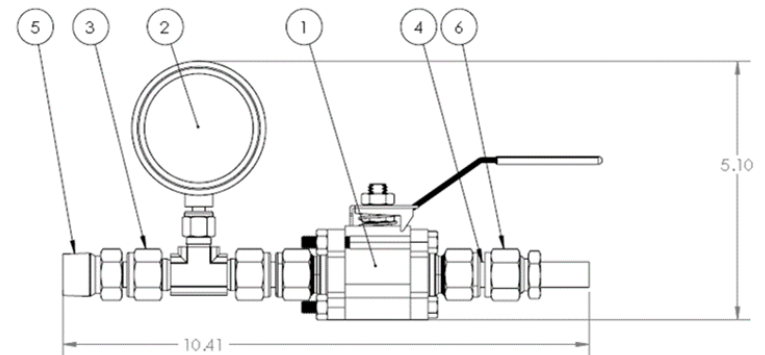
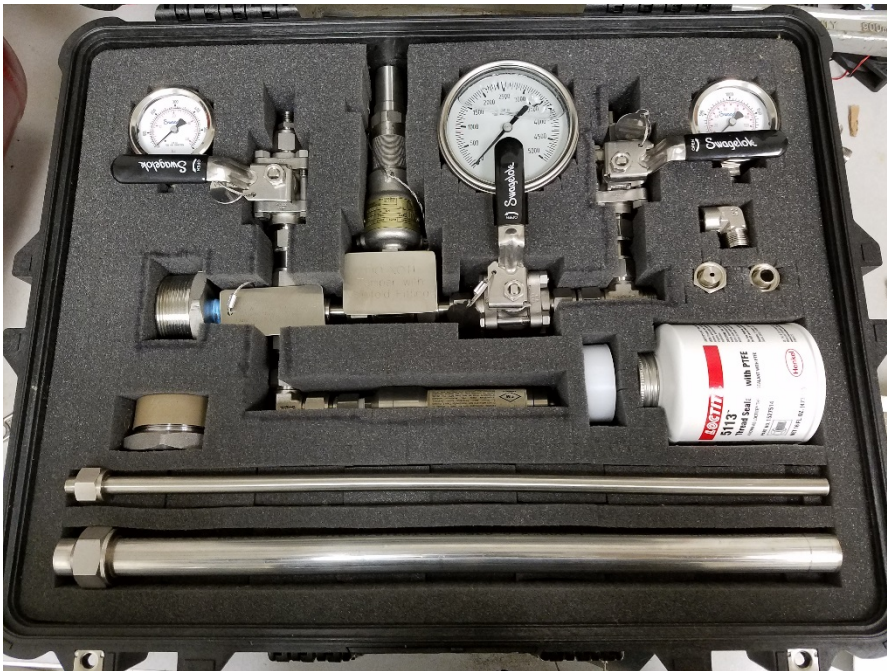

Technical Status- SCP Testing

- **MI Basins Site-** 23 CO₂ EOR wells circa 1960-2003 were surveyed.
- 6 wells identified with some indicators of potential SCP.



Technical Status- SCP Testing

- The 6 wells were tested for SCP.
- No significant pressure rebound observed, mostly temperature fx.

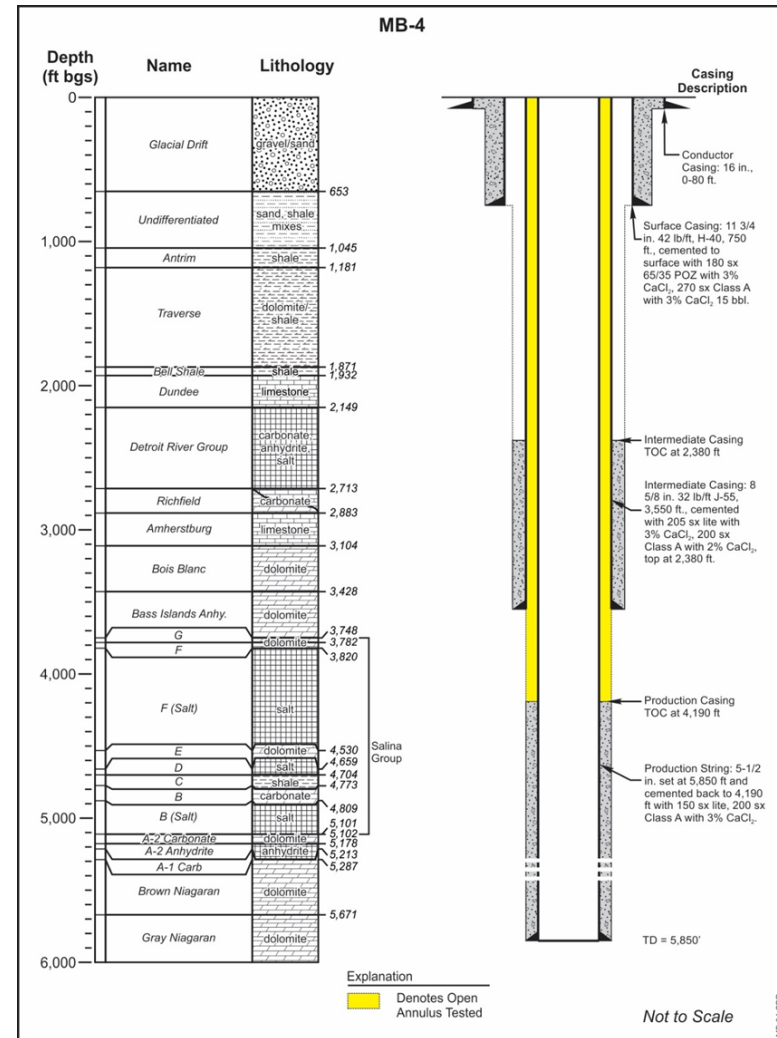
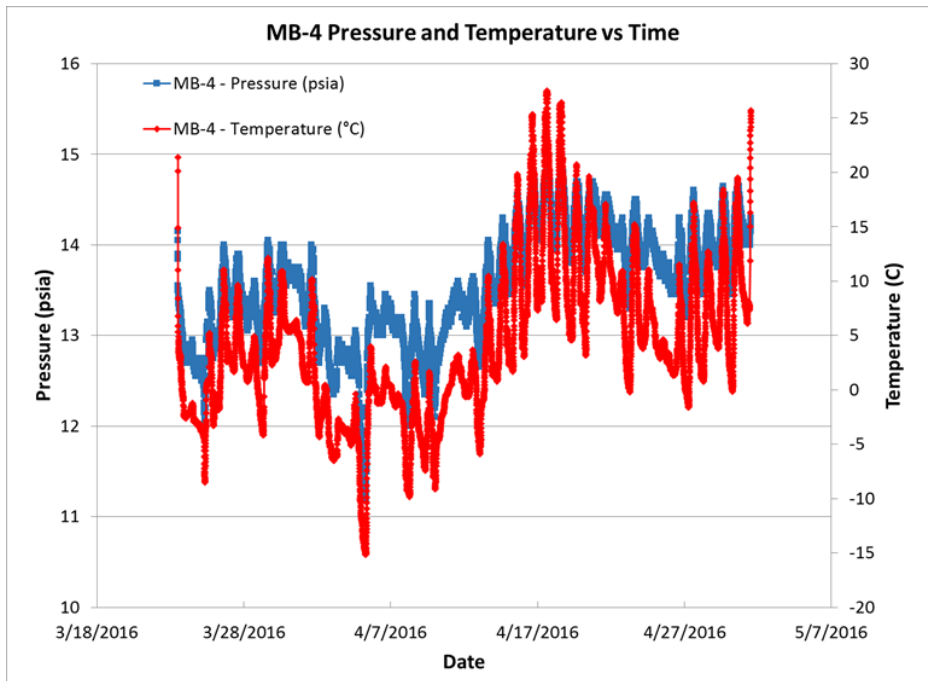

Technical Status- SCP Testing

- All pressures were <50 psi.
- Pressure did not rebound to initial levels in many wells.

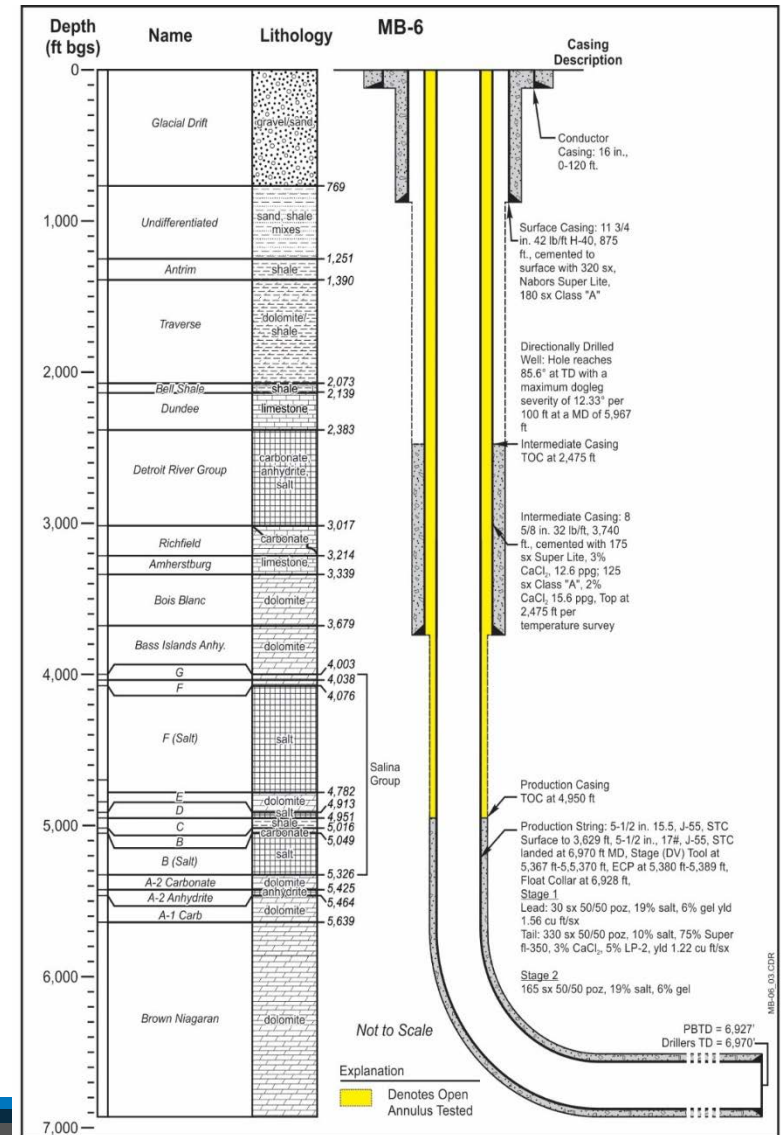
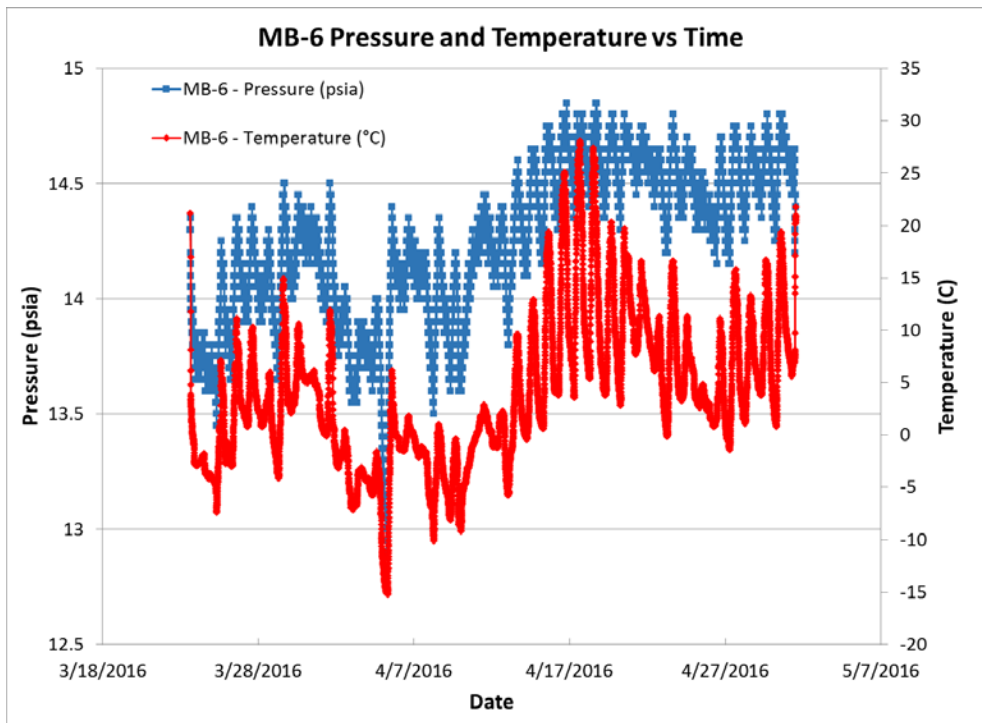

Technical Status- SCP Testing

- Gas sample analysis showed mostly methane, nitrogen, and hydrogen. Most likely from intermediate zones, atmosphere or cathodic protection.
- One well had higher CO₂ levels.

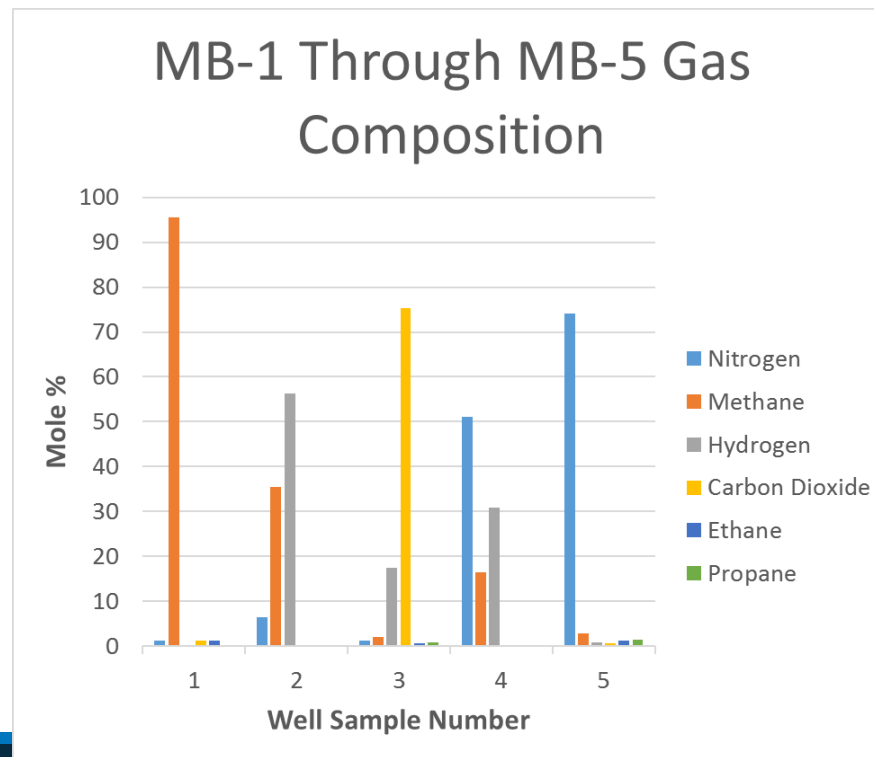

Technical Status- SCP Testing

- **Williston Basin site** SCP testing is planned in 30 CO₂ EOR wells for Summer-Fall 2017.
- Initial screening completed to identify wells for testing.
- Most wells appear to have lower SCP pressures (<60 psi).

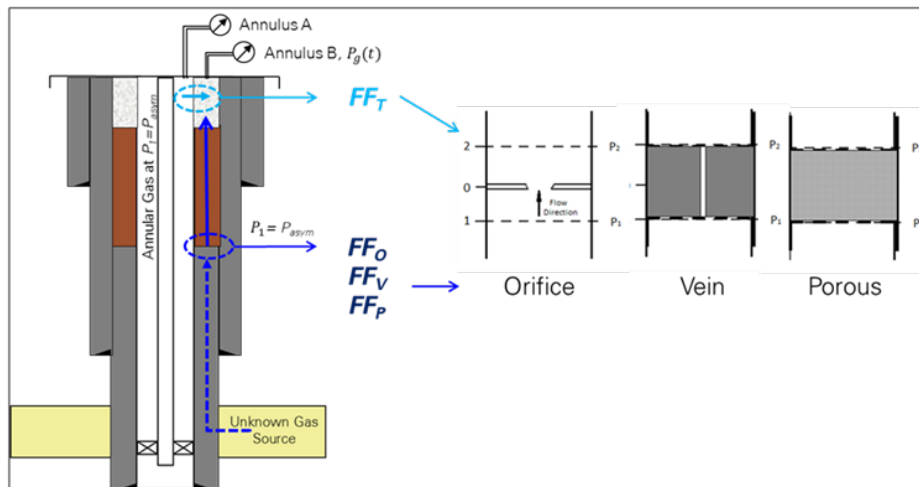

Technical Status- SCP Testing

- **Appalachian Basin site** sold to new operator, and the site was not available for SCP testing...but we continue discussions with the operator.
- Well history/record review indicates these wells did not have any more problems than typical oil & gas wells.

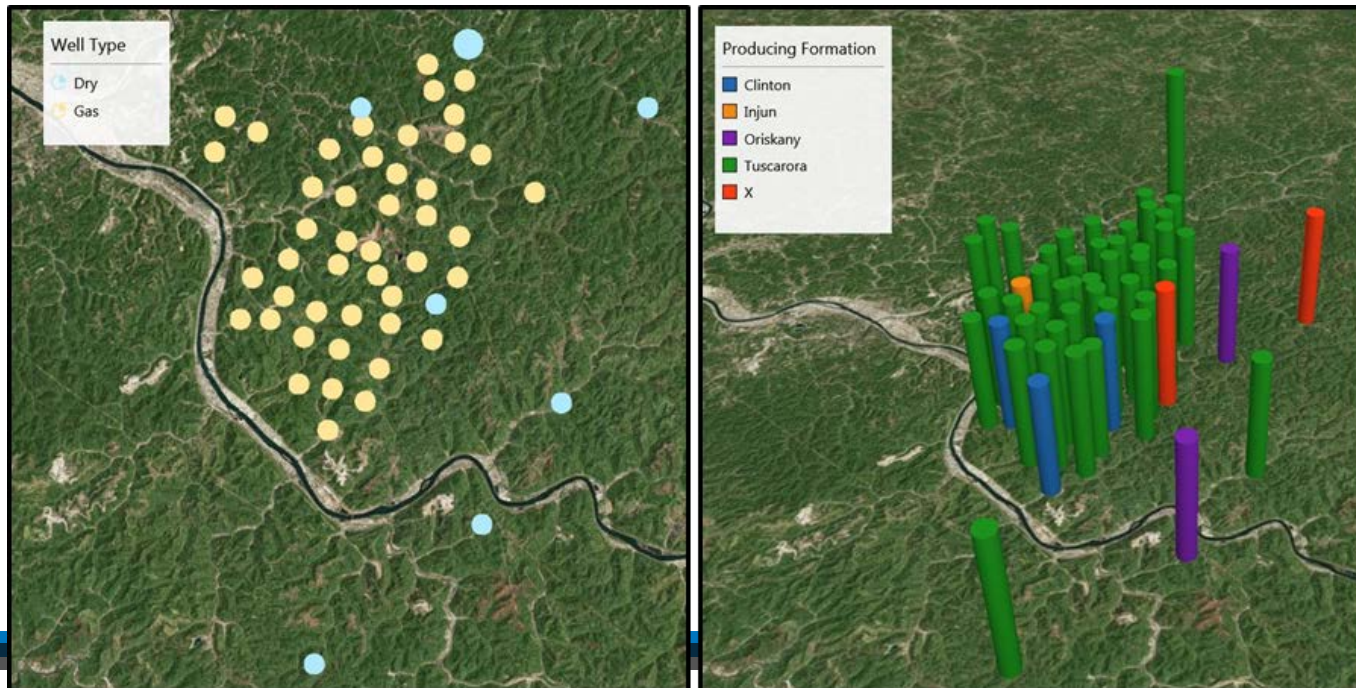

Technical Status

- Additional tasks on statistical machine based learning and uncertainty analysis of wellbore integrity metrics are planned in FY2019.
- Analytics with Machine Learning
 - Transform raw data into information for decision-making
 - Includes all of the infrastructure required to do that transformation:

- Data collection & management
- Predictive modeling

- Exploratory data analysis
- Visualization & reporting

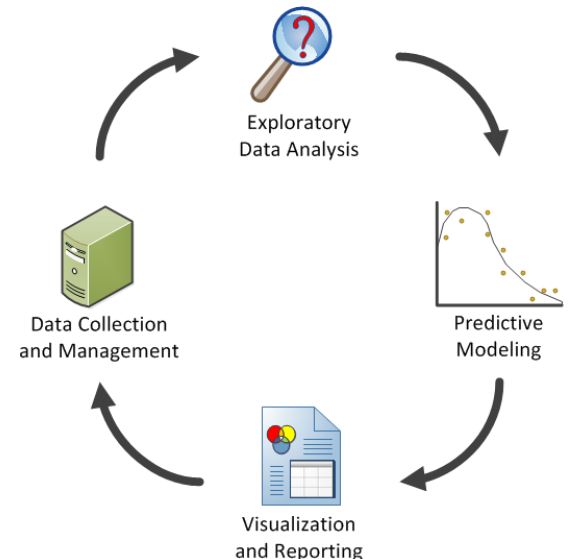

Technical Status

- Task 6.1 Well Integrity Regression Analysis
- Task 6.2 Data Analysis Algorithm Development
- Task 6.3 Meta-modeling on test fields

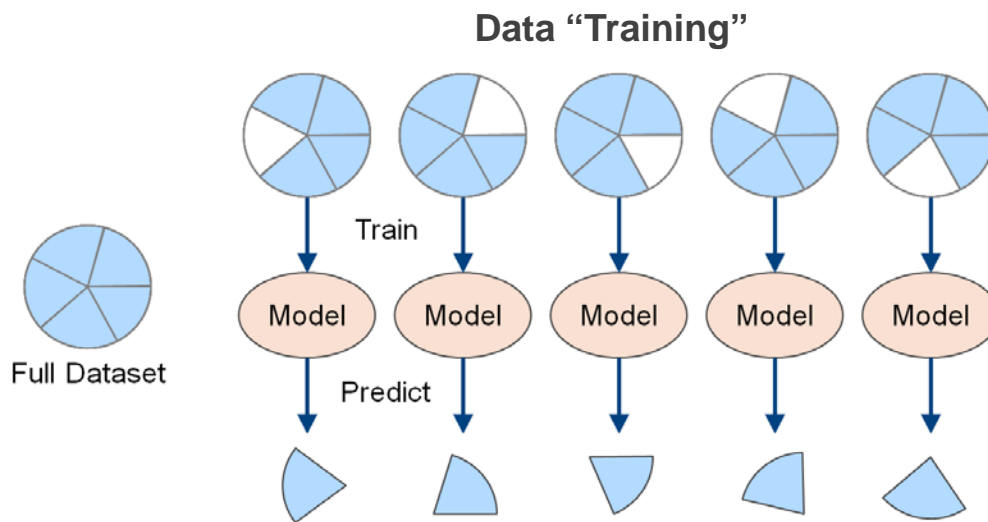

Source: Schuetter et al., 2105 SPE URTEC 2167005

Meta-Modeling "Sliders"

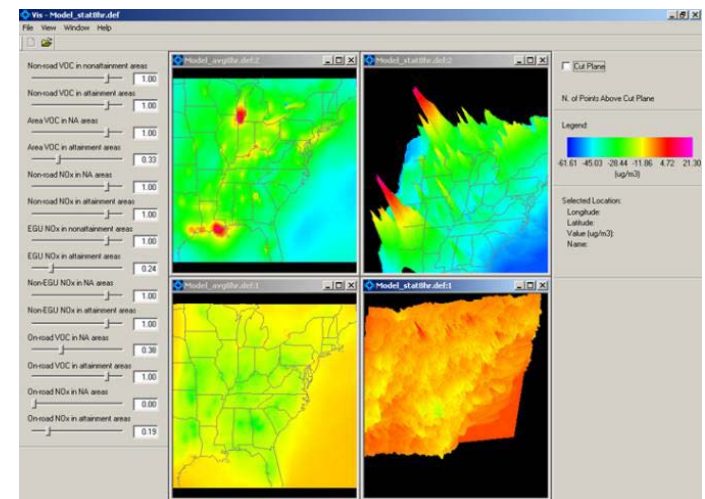

Accomplishments to Date

- This integrated approach brings together analysis of well information with field monitoring and testing:
 - Development of a registry of wellbore integrity factors,
 - Detailed review of fields (Michigan Basin, Appalachian Basin, w-central U.S.) with wells exposed to CO₂ in the subsurface,
 - Clear, direct, and cost effective field testing of wells with sustained casing pressure to determine the nature of well defects common to wells exposed to CO₂,
 - Advanced analytical processing of well construction parameters based on historical and spatial trends and machine learning to sustained casing pressure results.

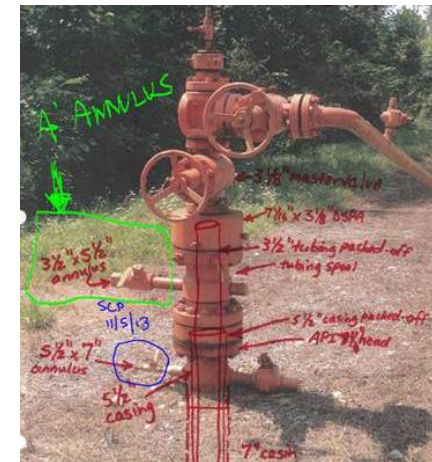

Accomplishments to Date

- Completed well integrity registry to identify processes that may affect wellbore (Task 2).
- Completed site characterization of geology, well construction, field history, well status, for test study areas in Appalachian Basin, Michigan Basin, and Williston Basin (Task 3).
- Completed sustained casing pressure testing in Michigan Basin site. Testing in-progress at Williston Basin Site. Appalachian Basin field sold to new operator so this study was more based on records/well history (Task 5).

Lessons Learned

- SCP testing/monitoring method is effective, direct, low-cost method to test/monitor wells for variety of defects.
- Method doesn't require well to be offline or service rig.
- Data may show defect nature, severity, and location.

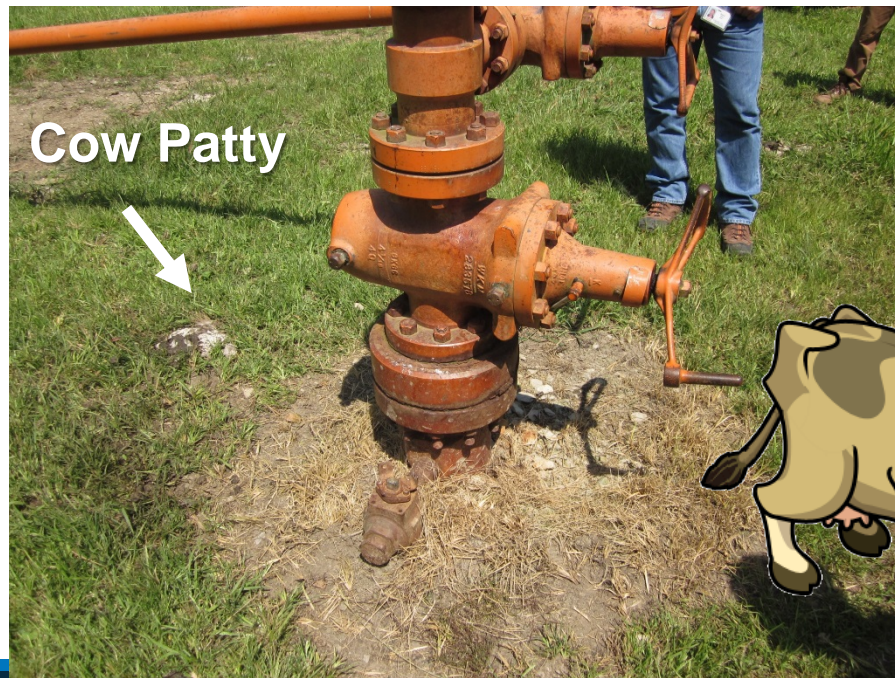

**Cow
Scratching
Post Well
Corrosion**

Lessons Learned

- 23 CO₂ wells were surveyed for casing pressure at Michigan Basin. 6 wells had indications of casing pressure and were tested for casing pressure buildup.
- These wells showed only minor casing pressure related to thermal effects.
- Overall, sustained casing pressure was not a common problem for the tested wells at the Michigan Basin site.
- Well construction practices were sufficient to isolate the injection zone and prevent any significant migration of CO₂ into the wellbore.

Lessons Learned

- Well construction methods that appear to have helped maintain wellbore integrity at the site include:
 - Multiple strings of casing (conductor, surface, intermediate, and deep) are present in the wells which reduces potential for gas migration from intermediate zones.
 - Most wells were cemented across or near casing string crossovers reducing pathways for gas migration along the boreholes.
 - More cement was used to cement in the casing strings than many other areas of the Midwest. Casing strings are cemented in with several hundred feet of cement, and in many cases over 1000 ft of cement.
 - Cement was allowed to set and the top of cement was tagged to confirm the top of cement, which was especially pertinent to this site because there was potential to lose cement in washout zones.

Lessons Learned

- Well records at an Appalachian Basin site did not show unusual well history related that would suggest substantial issues with these well exposed to a natural CO₂ field in the subsurface.
- Future work will expand sustained casing pressure testing to Williston Basin field to provide additional data on well integrity.
- Results will be analyzed with machine based learning methods to determine if certain well construction factors may be related to CO₂ corrosion.

Synergy Opportunities

- Project has significant synergies with other ongoing work on carbon storage technologies (carbon capture & storage), shale gas developments, other CO₂ storage research.
- Provides a better understanding of wellbore integrity in legacy oil and gas wells, a key issue for CO₂ storage in the region's deep rock formations.
- Reduces uncertainty related to siting CO₂ storage projects by providing direct testing of legacy CO₂ wells and relating this to >1 million oil and gas wells in the region.

Project Summary

- The project is designed to develop a comprehensive approach to analyzing wellbore integrity for CO₂ storage applications from start to finish.
- Results of the project will benefit CO₂ storage applications throughout the U.S. and advance technologies aimed at surveying, identifying, and characterizing well integrity factors.
- The project methods will be validated with actual well data from CO₂ environments, providing realistic results.

Thanks!

BATTELLE

It can be done

Appendix

Benefit to the Program

- This project addresses Funding Opportunity 1240 Area of Interest 2: Wellbore Leakage Identification and Characterization.
- The project is designed to establish an effective approach to determining the location/depth, nature, and severity of well integrity issues for wells exposed to CO₂ environments in the subsurface.
- Project results will provide new and improved predictive methods to survey, identify, characterize, and manage wellbore integrity defects for CO₂ storage applications.

Project Overview

- The objective of this project is to develop and validate a program for identifying and characterizing wellbore leakage potential for CO₂ storage applications based on analytics of well records validated with sustained casing pressure field monitoring.
- The project will develop and advance technologies that will significantly improve the effectiveness and reduce the cost of implementing carbon storage.
- Integration of casing pressure test results with automated machine based learning analytics can identify wells with poor integrity
- Development of an integrated program to identify, survey, measure, analyze, and remediate CO₂ migration in wellbores.
- In addition, the type of well defect (micro-annulus, cracks, cement voids, and incomplete cement coverage) may be better characterized to select to the most appropriate remediation technology.

Organization Chart

3-Year Project; October 2015 - September 2018

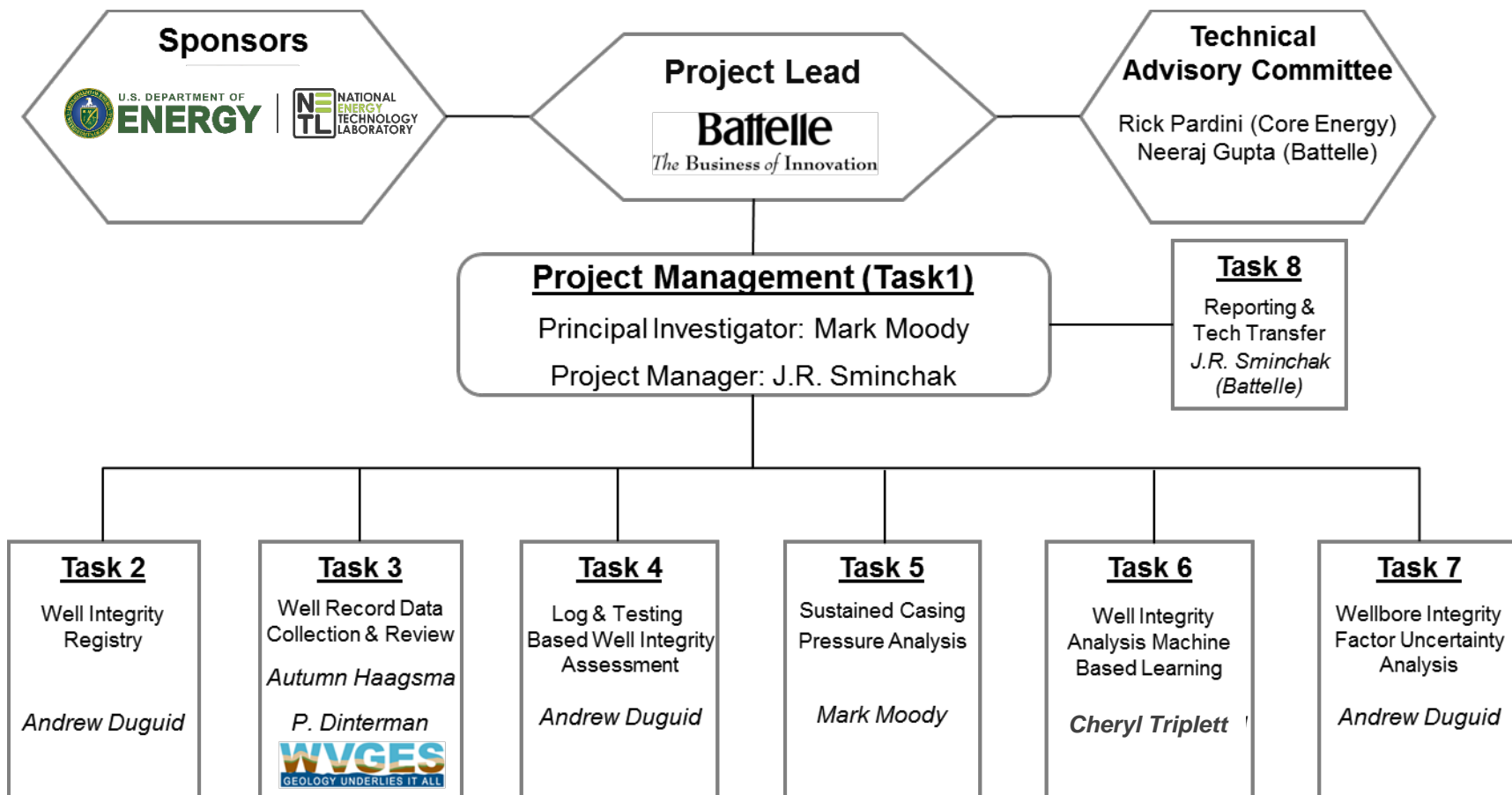

Gantt Chart

- Project is designed with a sequential series of tasks over 3 years.

| Task Name | BP1 | | | | BP2 | | | | BP3 | | | |
|--|---------|----|----|----|--------|----|----|----|--------|----|----|----|
| | FY2016 | | | | FY2017 | | | | FY2018 | | | |
| | Q1 | Q2 | Q3 | Q4 | Q1 | Q2 | Q3 | Q4 | Q1 | Q2 | Q3 | Q4 |
| Task 1: Project Management & Planning | ●-----● | | | | | | | | | | | |
| 1.1 Update Project Mgmt. Plan | ◆ | | | | | | | | | | | |
| 1.2 Project Management | | | | | | | | | | | | |
| 1.3 Progress Reporting | | | | | | | | | | | | |
| 1.4 Project Controls | | | | | | | | | | | | |
| 1.5 NEPA Reporting | | | | | | | | | | | | |
| Task 2: Well Integrity Registry | ●-----● | | | | | | | | | | | |
| 2.1 Well Construction Methods | | | | | | | | | | | | |
| 2.2 Well Casing Integrity Issues | | | | | | | | | | | | |
| 2.3 Well Cement Issues | | | | | | | | | | | | |
| 2.4 Geologic Processes | | | | | | | | | | | | |
| 2.5 CO2 Environments | | | | | | | | | | | | |
| Task 3: Well Record Data Collection & Rev. | ●-----● | | | | | | | | | | | |
| 3.1 Cement & Drilling Records | | | | | | | | | | | | |
| 3.2 Operational Records | | | | | | | | | | | | |
| 3.3 Well Workover/Leakage Records | | | | | | | ◆ | | | | | |
| Task 4: Log & Testing Based Well Int. Asmt. | ●-----● | | | | | | | | | | | |
| 4.1 Log Analysis | | | | | | | | | | | | |
| 4.2 Well Record Analysis | | | | | | | | | | | | |
| 4.3 Well Integrity Evaluation | | | | | | | | | | | | |
| Task 5: Sustained Casing Pressure Analysis | ●-----● | | | | | | | | | | | |
| 5.1 SCP Field Site Description | | | | | | | | | | | | |
| 5.2 SCP Field Data Collection | | | | | | | | | | | | |
| 5.2 SCP Data Analysis | | | | | | | | | | ◆ | | |
| Task 6: Well Integrity w/Machine Learning | ●-----● | | | | | | | | | | | |
| 6.1 Well Int. Regression of Well Int. Indicators | | | | | | | | | | | | |
| 6.2 Data Analysis Algorithm Dev.w/Mach. Lrng | | | | | | | | | | | | |
| 6.3 Meta-Modeling on Test Fields | | | | | | | | | | | | |
| Task 7: WBI Uncertainty Factor Analysis | ●-----● | | | | | | | | | | | |
| 7.1 WBI Identification | | | | | | | | | | | | |
| 7.3 Uncertainty Reduction | | | | | | | | | | | | |
| Task 8: Reporting and Tech Transfer | ●-----● | | | | | | | | | | | |
| 9.1 Progress Reports | ◆ | ◆ | ◆ | ◆ | ◆ | ◆ | ◆ | ◆ | ◆ | ◆ | ◆ | ◆ |
| 9.2 Technical Reports | | | | ◆ | | ◆ | | ◆ | | | ◆ | ◆ |
| 9.3 Final Reporting | | | | | | | | | | | | |
| 9.4 Project Meetings | | | | | | | | | | | | |
| 9.4 DOE BPM | ◆ | ◆ | ◆ | ◆ | ◆ | ◆ | ◆ | ◆ | ◆ | ◆ | ◆ | ◆ |

Bibliography

- *Case Study on Wellbore Integrity for Two Fields with Wells Exposed to CO₂ in the Subsurface in the Midwest U.S.* Jacob Markiewicz, J.R. Sminchak, and Mark Moody. SPE Eastern Section Regional Meeting, 4-6 October 2017, Lexington, Kentucky.
- *Is your well flat or carbonated? What sustained casing pressure testing and beer have in common.* J.R. Sminchak. 11th IEAGHG Monitoring Network Meeting. June 13-15, Traverse City Michigan.
- *Field Testing and Well History Analysis on Wells Exposed to CO₂ in the Subsurface in the Midwest U.S.*, J.R. Sminchak, Mark Moody, Autumn Haagsma, Andrew Duguid, Matt Place, and Neeraj Gupta. Carbon Capture, Utilization, and Storage Conference, June 14-16, 2016, Tysons, VA, USA.
- A project overview presentation given by J.R. Sminchak at the DOE-NETL Carbon Storage Program Review Meeting in Pittsburgh, Pennsylvania, August 16-18, 2016.
- *Sustained Casing Pressure Diagnosis with Extended Data Collection*, **Matt Place**, Glenn Larsen, Bryan Dotson, Nigel Jenvey, and Mark Moody, SPE Eastern Regional Meeting, 13-15 October 2015, Morgantown, WV.
- *Sustained Casing Pressure Diagnosis Using the Wellhead Model*, Bryan Dotson, **Mark Moody**, and Matthew Place, SPE/CSGM Gas Migration Challenges – Identification and Treatment Workshop, May 13-14, 2015 Banff, Alberta, Canada.
- **J.R. Sminchak**, Mark Moody, Andrew Theodos, Glenn Larsen, and Neeraj Gupta. 2014. *Investigation of wellbore integrity factors in historical oil and gas wells for CO₂ geosequestration in the Midwestern U.S.* *Energy Procedia* (2014), pp. 5787-5797. <http://dx.doi.org/10.1016/j.egypro.2014.11.611>